

IMPORTANT SAFETY RULES

Read, understand, and follow all instructions carefully before installing and using this product.

Electric Pool Heater

Model HT30220

230 V~, 50 Hz, 3000 W, IP25

Max. Water Temperature 35°C



For illustrative purposes only.

Don't forget to try these other fine Intex products: Pools, Pool Accessories, Inflatable Pools and In-Home Toys, Airbeds and Boats available at fine retailers or visit our website.

Due to a policy of continuous product improvement, Intex reserves the right to change specifications and appearance, which may result in updates to the instruction manual without notice.

INTEX®

©2020 Intex Marketing Ltd. - Intex Development Co. Ltd. - Intex Recreation Corp. All rights reserved/Tous droits réservés/Todos los derechos reservados/Alle Rechte vorbehalten. Printed in China/Imprimé en Chine/Impreso en China/Gedruckt in China.

®™ Trademarks used in some countries of the world under license from/®™ Marques utilisées dans certains pays sous licence de/Marcas registradas utilizadas en algunos países del mundo bajo licencia de/Warenzeichen verwendet in einigen Ländern der Welt in Lizenz von/Intex Marketing Ltd. to/a/a/an Intex Development Co. Ltd., G.P.O Box 28829, Hong Kong & Intex Recreation Corp., P.O. Box 1440, Long Beach, CA 90801 • Distributed in the European Union by/Distribué dans l'Union Européenne par/Distribuido en la unión Europea por/Vertrieb in der Europäischen Union durch/Intex Trading B.V., Venneveld 9, 4705 RR Roosendaal – The Netherlands
www.intexcorp.com

TABLE OF CONTENTS

Warnings..... 3-4

Parts Reference..... 5

Set Up Instructions..... 6

Operating Instructions..... 7

Operating Time Table..... 8

Long Term Storage..... 8

**Electric Pool Heater
Stationary Mounting Option**..... 9

Pool Care and Chemicals..... 9

Troubleshooting Guide..... 10

Common Pool Problems..... 11

General Aquatic Safety..... 11

Limited Warranty..... 12

Filter Pump Flow Rate Requirement:

500 - 2500 gallons/hour (1893 - 9464 liters/hour)

Working Water Temperature:

63 degrees Fahrenheit (17 degrees Celsius) to 95 degrees Fahrenheit (35 degrees Celsius)

Suitable to be used for pool with water capacity:

below 4500 gallons (17033 liters)

Types of Pool	Gallons (pool size in feet)	Cubic Meters (pool size in meters)
Rectangular	Length x Width x Average Depth x 7.5	Length x Width x Average Depth
Circular	Length x Width x Average Depth x 5.9	Length x Width x Average Depth x 0.79
Oval	Length x Width x Average Depth x 6.0	Length x Width x Average Depth x 0.80

SAVE THESE INSTRUCTIONS

IMPORTANT SAFETY RULES

Read, Understand and Follow All Instructions Carefully Before Installing and Using this Product.



WARNING

- To reduce the risk of injury, do not permit children to use this product. Always supervise children and those with disabilities.
- Do not bury electrical cord. Locate cord where it will not be damaged by lawn mowers, hedge trimmers, and other equipment.
- If the supply cord is damaged, it must be replaced by the manufacturer, its service agent or similarly qualified persons in order to avoid a hazard.
- To reduce the risk of electric shock, do not use extension cords, timers, plug adaptors or converter plugs to connect unit to electric supply; provide a properly located outlet.
- Provide a dedicated electrical outlet socket with a rating of 16 Amp. or more. Make sure the RCD plug fit tightly and securely into the electrical outlet socket. If not sure contact a qualified electrician.
- Assembly and disassembly by adults only.
- Do not attempt to plug in or unplug this product while standing in water or when your hands are wet.
- Position this product away from pool to prevent a child from climbing on product to access the pool.
- Children must stay away from this product and electrical cord(s).
- Do not operate this product when pool is occupied.
- Always unplug this product from the electrical outlet before removing, cleaning, servicing or making any adjustment to the product.
- Always position the pool heater below the level of the pool hose connection during use.
- Place the product in an upright position.
- Do not switch on if there is no water in the product.
- Do not switch on if there is a possibility that the water in the product is frozen.
- For above ground pool use only. Do not use for spa.
- Do not lift up the product by holding the power cord.
- Have a qualified electrician install a property grounded receptacle outlet, acceptable for outdoor use and protected from snow and rain, immediately adjacent to the location where the heater will be used.
- Route the supply cord and locate the heater so as to be protected from damage by animals.

SAVE THESE INSTRUCTIONS

IMPORTANT SAFETY RULES

114A

Read, Understand and Follow All Instructions Carefully Before Installing and Using this Product.



WARNING

- Do not use extension cords.
- Inspect cord before using.
- Unplug heater at receptacle outlet when not in use or before removing from pool.
- Store heater indoors after the end of your swimming season.
- The outlet must not be connected to any tap or fitting other than those specified.
- Keep this product more than 2m away from the pool (For France only).
- Keep the plug of this product more than 3.5m away from the pool.
- The plug shall be accessible after product installed.
- This appliance can be used by children aged from 8 years and above and persons with reduced physical, sensory or mental capabilities or lack of experience and knowledge if they have been given supervision or instruction concerning use of the appliance in a safe way and understand the hazards involved.
- Children shall not play with the appliance. Cleaning and user maintenance shall not be made by children without supervision.
- This product is intended to be used only for the purposes described in the manual!

FAILURE TO FOLLOW THESE WARNINGS MAY RESULT IN PROPERTY DAMAGE, ELECTRIC SHOCK, ENTANGLEMENT OR OTHER SERIOUS INJURY OR DEATH.

These product warnings, instructions and safety rules provided with the product represent some common risks of water recreation devices and do not cover all instances of risk and danger. Please use common sense and good judgement when enjoying any water activity.

SAVE THESE INSTRUCTIONS

PARTS REFERENCE

Before assembling your product, please take a few minutes to check the contents and become familiar with all the parts.

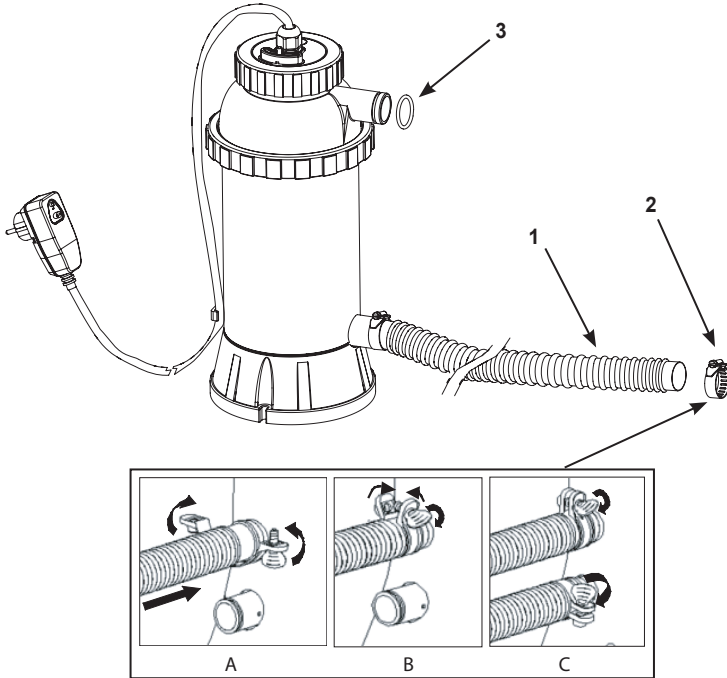

REF. NO.	DESCRIPTION	QTY.	SPARE PART NO.
1	HOSE	1	10116
2	HOSE CLAMP	2	11489
3	HOSE SEAL	2	10134

When ordering parts, be sure to quote the model number and part numbers.

SAVE THESE INSTRUCTIONS

Page 5

SET UP INSTRUCTIONS

The appliance is ready to work under the following conditions:

FREE CHLORINE (HClO + ClO ⁻ + Cl ₂)	up to 3 ppm
pH	6.8 - 8.0
CHLORIDES	up to 250 ppm
ISOCYANIC ACID	up to 100 ppm
CALCIUM HARDNESS	up to 500 ppm
BROMIDE (HBrO)	up to 8 ppm

IMPORTANT: The electrical pool heater must be installed as the last piece of pool equipment before the saltwater pool or chlorine generator system in the water return line to the pool.

1. Assemble the above-ground-pool (AGP) and its filter pump per installation instructions.
2. Remove the electrical pool heater and its accessories from the packaging.
3. Place the electrical pool heater in line after the filter pump.
4. Connect the hose (1) to the electrical pool heater inlet. (See following page).
5. If your above-ground-pool is filled up with water, unscrew the strainer grids from the strainer connectors and insert the black hat-like plugs into the strainer connectors before electrical pool heater installation. Go to step 6 directly if your pool is empty.
6. Disconnect the water return (to the pool) hose from the filter pump connection, and connect it to the upper electric pool heater connection with a hose clamp.
7. Connect the second hose to the lower electric pool heater connection and to the lower pump connection. Make sure all the hose clamps (2) are tight.
8. If applicable, return strainer grids to strainer connectors inside pool after removing black hat-like plugs that prevented water from flowing out of the pool.
9. Connect the electric pool heater to the power outlet. Test RCD as shown on following page.
10. Turn pump on. Check water is flowing through the heater. Then turn heater on.

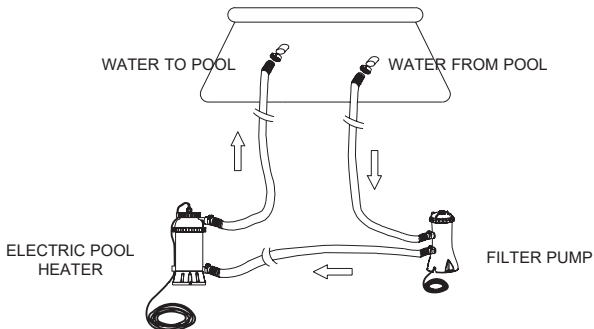

IMPORTANT

If the heater is not in an upright position a safety switch will automatically turn the heater off. Be sure the heater is always in an upright position while the cord is connected to the power outlet.
Filter pump must be operating before turning on heater.

SAVE THESE INSTRUCTIONS

RCD OPERATING INSTRUCTIONS

114A

1. Plug RCD into power outlet. Press RESET button on the RCD plug. Indicator should be "ON". See FIG. 1.
2. Press T button on the RCD plug. Indicator should be "OFF". See FIG. 2.
3. Press RESET button for use. Do not use if test fails. Contact a qualified electrician to determine cause of failure.

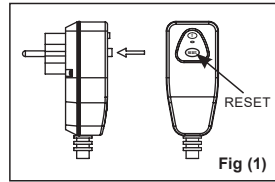

Fig (1)

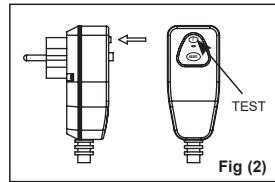

Fig (2)

OPERATING INSTRUCTIONS

1. Switch the knob clockwise to the "I" position to turn the electric pool heater on. See FIG. 3.
2. The red indicator light on the heater top will light up indicating heater is operating.
3. Switch the knob counter-clockwise to the "0" position to turn the electric pool heater off. See FIG. 4.
NOTE: Turn off the heater before turning off the filter pump or entering the pool.
4. The red indicator light on the heater top will turn off.

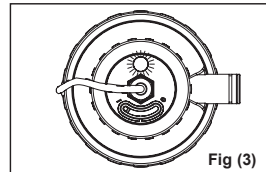

Fig (3)

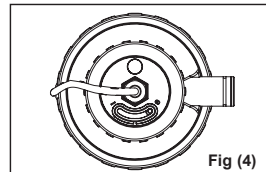

Fig (4)

SPECIAL NOTES

- Always use a thermometer to test the pool water temperature before entering or using the pool. If the thermometer indicated water temperature is over 95 degrees Fahrenheit (35 degrees Celsius), wait until the indicated water temperature drops below 95 degrees Fahrenheit (35 degrees Celsius) before using the pool, or below 82 degrees Fahrenheit (28 degrees Celsius) before operating the electric pool heater again.

IMPORTANT

NEVER use the pool if indicated water temperature is more than 95 degrees Fahrenheit (35 degrees Celsius). Do not operate electric pool heater while the pool is in use or occupied.

SAVE THESE INSTRUCTIONS

Page 7

OPERATING TIME TABLE

Pool Type		Water Capacity (Calculated at 90% for Frame Pool and 80% for Easy Set & Oval Pool)		Time to increase by 1 degree Fahrenheit	Time to increase by 1 degree Celsius
		(Gals)	(Liters)		
INTEX ABOVE GROUND POOLS (AGP's)					
EASY SET® POOL	8' x 27" (244cm x 68cm)	577	2184	1.0	1.5
	8' x 30" (244cm x 76cm)	639	2420	1.0	1.5
	10' x 30" (305cm x 76cm)	1018	3854	1.0	2.0
	12' x 30" (366cm x 76cm)	1485	5619	1.5	3.0
	12' x 36" (366cm x 91cm)	1779	6732	2.0	4.0
	12' x 42" (366cm x 107cm)	2454	9290	2.5	5.0
	15' x 36" (457cm x 91cm)	2822	10680	3.0	6.0
ROUND METAL FRAME POOL	15' x 42" (457cm x 107cm)	3284	12431	4.0	7.0
	10' x 30" (305cm x 76cm)	1185	4485	1.5	2.5
	12' x 30" (366cm x 76cm)	1718	6503	2.0	3.5
	15' x 36" (457cm x 91cm)	3282	12422	4.0	7.0
	15' x 42" (457cm x 107cm)	3861	14614	4.5	8.0
SMALL RECTANGULAR METAL FRAME POOL	15' x 48" (457cm x 122cm)	4440	16806	5.0	9.0
	86-5/8" x 59" x 23-5/8" (220cm x 150cm x 60cm)	439	1663	0.5	1.0
	102-1/2" x 63" x 25-5/8" (260cm x 160cm x 65cm)	603	2284	1.0	1.5
	118" x 78-3/4" x 29-1/2" (300cm x 200cm x 75cm)	1013	3834	1.0	2.0
	149-5/8" x 78-3/4" x 31-1/2" (380cm x 220cm x 80cm)	1373	5198	1.5	3.0
177-1/4" x 86-5/8" x 33-1/2" (450cm x 220cm x 85cm)	1907	7217	2.0	4.0	

Notices:

- The table above is for reference only. Data were drawn under pool water temperature 77 degrees Fahrenheit (25 degrees Celsius), covered by solar cover during the sunny day.
- The ambient temperatures of air and water have an effect on the water heat up efficiency.

LONG TERM STORAGE

1. Before emptying your pool for long term storage, or relocation, be sure the water is directed towards an acceptable drain water receptacle away from the house. Check local regulations for specific directions regarding disposal of swimming pool water.
2. Disconnect power cord from electrical outlet.
3. After pool is emptied of all water, disconnect the electric pool heater from the hoses reversing the installation instructions.
4. Air-dry the unit before storage.
5. Store the unit and accessories in a dry, temperature controlled, between 32 degrees Fahrenheit (0 degrees Celsius) and 104 degrees Fahrenheit (40 degrees Celsius) storage location.
6. The original packing carton can be used for storage.

SAVE THESE INSTRUCTIONS

ELECTRIC POOL HEATER STATIONARY MOUNTING OPTION

Some countries, especially in the European community, require the electric pool heater to be secured to the ground or to a base in a permanent upright position. Check your local authorities to determine if there is a regulation in your area regarding above-the-ground swimming pool electric pool heaters. If yes, then the electric pool heater can be mounted to a platform using the two holes located in the base. See drawing below.

The electric pool heater can be mounted on a cement base or onto a wooden platform to prevent accidental falling over. Total assembly must exceed 18kg. The European norm EN 60335-2-41 requires this product be secured to the ground or to a base.

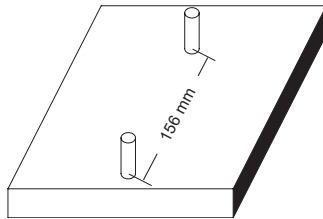

1. The mounting holes are 6.4 mm in diameter and spaced 156 mm apart.
2. Use two bolts and lock nuts with a maximum of 6.4 mm in diameter.

POOL CARE AND CHEMICALS

- All pools require care to keep the water clear and hygienically clean. With proper chemical control, your filter will help attain this objective. Consult your pool supply dealer for instructions regarding the proper use of chlorine, algaecide and other chemical agents required for sparkling clear water.
- Keep pool chemicals away from children.
- Do not replenish chemicals in pool while pool is occupied. Skin or eye irritations could occur.
- Daily pH checking and chemical treatment of the water is very important and can not be overemphasized. Chlorine, algaecide and maintenance of proper pH levels are required when filling the pool as well as during the season. Consult your local swimming pool supply store for instructions.
- The season's first filling of the pool may have brackish water requiring extra water additives and extra filter changes. Do not allow swimming in pool until the pH level is balanced. Consult your local swimming pool supply store for instructions.
- Keep spare filter cartridges on hand. Replace cartridges every two weeks.
- Chlorinated water may damage lawns, gardens or shrubbery as children play in the pool and splash water outside the pool. Lawn areas underneath the pool liner will be destroyed. Note that some types of grass may grow through the liner but function is not affected.

SAVE THESE INSTRUCTIONS

TROUBLESHOOTING GUIDE

PROBLEM	CAUSE	REMEDY
THE RED INDICATOR DOES NOT LIGHT UP DURING USE	1. The power cord is not plugged in.	• Plug in the power cord.
	2. The knob is not fully switched to on position – “I”.	• Switch the knob clockwise to the “I” position to turn the electric pool heater on.
	3. The GFCI/RCD plug is not turned on.	• Re-plug the GFCI/RCD and press the “RESET” button.
	4. The water temperature is too high.	• The temperature sensor will cut off the power of heater when the water temperature is above approximately 95°F (35°C). It continues to work when the water temperature drop below approximately 82°F (28°C).
	5. No water flow.	• Turn on the filter pump.
	6. Low water flow.	• Ensure the plunger valves are opened (if any). • Ensure your filter cartridges are clear from debris and dirt. • Release all trapped air in the circulation line. • Check for the direction of water inlet and water outlet hose. Reverse the hose if necessary.
THE WATER TEMPERATURE DOES NOT INCREASE ALTHOUGH THE RED INDICATOR IS LIT UP	1. Pool or solar cover not been used.	• Always use the solar cover if the pool is not occupied.
	2. The pool size or water capacity exceeds the heater capacity.	• Increase the heating time properly.
	3. The water temperature is too low.	
THE WATER TEMPERATURE IS TOO HIGH	1. Heating time too long.	• Stop the heater and shorten the heating time.
HOSE LEAKING	1. Hose clamps.	• Tighten/reinstall hose clamps.
	2. Hose seals.	• Reposition/replace hose seals.
GFCI/RCD KEEPS TRIPPING OFF	1. Product failure or electrical circuit problem.	• Unplug the GFCI/RCD and then re-plug in and press the “RESET” button to start the heater. Contact Intex Service Center if it trips off continuously.

IMPORTANT

If you continue to experience difficulty, please contact our Consumer Service Department for assistance. See separate “Authorized Service Centers” sheet.

SAVE THESE INSTRUCTIONS

COMMON POOL PROBLEMS

PROBLEM	DESCRIPTION	CAUSE	REMEDY
ALGAE	<ul style="list-style-type: none"> Greenish water. Green or black spots on pool liner. Pool liner is slippery and/or has a bad odor. 	<ul style="list-style-type: none"> Chlorine and pH levels need adjustment. 	<ul style="list-style-type: none"> Super chlorinate with shock treatment. Correct pH to your pool store's recommended level. Vacuum pool bottom. Maintain proper chlorine level.
COLORED WATER	<ul style="list-style-type: none"> Water turns blue, brown, or black when first treated with chlorine. 	<ul style="list-style-type: none"> Copper, iron or manganese in water being oxidized by the added chlorine. 	<ul style="list-style-type: none"> Adjust pH to recommended level. Run filter until water is clear. Clean cartridge frequently.
SUSPENDED MATTER IN WATER	<ul style="list-style-type: none"> Water is cloudy or milky. 	<ul style="list-style-type: none"> "Hard water" caused by pH level being too high. Chlorine content is low. Foreign matter in water. 	<ul style="list-style-type: none"> Correct pH. Check with pool dealer for water treatment. Check for proper chlorine level. Clean or replace your filter.
CHRONIC LOW WATER LEVEL	<ul style="list-style-type: none"> Level is lower than on previous day. 	<ul style="list-style-type: none"> Rip or hole in pool liner or hoses. 	<ul style="list-style-type: none"> Repair with patch kit. Finger tighten all caps.
SEDIMENT ON POOL BOTTOM	<ul style="list-style-type: none"> Dirt or sand on pool floor. 	<ul style="list-style-type: none"> Heavy use, getting in and out of pool. 	<ul style="list-style-type: none"> Use Intex pool vacuum to clean bottom of pool.
SURFACE DEBRIS	<ul style="list-style-type: none"> Leaves, insects etc. 	<ul style="list-style-type: none"> Pool too close to trees. 	<ul style="list-style-type: none"> Use Intex pool skimmer.

GENERAL AQUATIC SAFETY

Water recreation is both fun and therapeutic. However, it involves inherent risks of injury and death. To reduce your risk of injury, read and follow all product, package and package insert warnings and instructions. Remember, however, that product warnings, instructions and safety guidelines cover some common risks of water recreation, but do not cover all risks and or dangers.

For additional safeguards, also familiarize yourself with the following general guidelines as well as guidelines provided by nationally recognized Safety Organizations:

- Demand constant supervision. A competent adult should be appointed as a "lifeguard" or water watcher, especially when children are in and around the pool.
- Learn to swim.
- Take the time to learn CPR and first aid.
- Instruct anyone who is supervising pool users about potential pool hazards and about the use of protective devices such as locked doors, barriers, etc.
- Instruct all pool users, including children what to do in case of an emergency.
- Always use common sense and good judgement when enjoying any water activity.
- Supervise, supervise, supervise.

SAVE THESE INSTRUCTIONS

LIMITED WARRANTY

Your Electric Pool Heater has been manufactured using the highest quality materials and workmanship. All Intex products have been inspected and found free of defects prior to leaving the factory. This limited warranty applies only to the Electric Pool Heater and accessories listed below.

This limited warranty is in addition to, and not a substitute for, your legal rights and remedies. To the extent that this warranty is inconsistent with any of your legal rights, they take priority. For example, consumer laws across the European Union provide statutory warranty rights in addition to the coverage you receive from this limited warranty: for information on EU-wide consumer laws, please visit the European Consumer Center website at http://ec.europa.eu/consumers/ecc/contact_en/htm.

The provisions of this limited warranty apply only to the original purchaser and is not transferable. This limited warranty is valid for the period noted below from the date of the initial retail purchase. Keep your original sales receipt with this document, as proof of purchase will be required and must accompany warranty claims or the limited warranty will be invalid.

Electric Pool Heater Warranty – 1 Year
Hoses Warranty – 180 days

If you find a manufacturing defect in the Electric Pool Heater during the warranty periods noted above, please contact the appropriate Intex Service Center listed in the separate "Authorized Service Centers" sheet. If the item is returned as directed by the Intex Service Center, the Service Center will inspect the item and determine the validity of the claim. If the item is covered by the provisions of the warranty, the item will be repaired or replaced, with the same or comparable item (at Intex's choice) at no charge to you.

Other than this warranty, and other legal rights in your country, no further warranties are implied. To the extent possibly in your country, in no event shall Intex be liable to you or any third party for direct or consequential damages arising out of the use of your Electric Pool Heater, or Intex or its agents' and employees' actions (including the manufacture of the product). If your country does not allow the exclusion or limitation of incidental or consequential damages, this limitation or exclusion does not apply to you.

You should note that this limited warranty does not apply in the following circumstances:

- If the Electric Pool Heater is subject to negligence, abnormal use or application, accident, improper operation, improper voltage or current contrary to operating instructions, improper maintenance or storage;
- If the Electric Pool Heater is subject to damage by circumstances beyond Intex's control, including but not limited to, ordinary wear and tear and damage caused by exposure to fire, flood, freezing, rain, or other external environmental forces;
- To parts and components not sold by Intex; and/or
- To unauthorized alterations, repairs or disassembly to the Electric Pool Heater by anyone other than Intex Service Center personnel.

The costs associated with the loss of pool water, chemicals or water damage are not covered by this warranty. Injury or damage to any property or person is not covered by this warranty.

Read the owner's manual carefully and follow all instructions regarding proper operation and maintenance of your Electric Pool Heater. Always inspect your product prior to use. This limited warranty will be void if use instructions are not followed.

SAVE THESE INSTRUCTIONS